



Gard Jaluze ZINCAT (dezasamblat)

CADRU Gard Jaluze

Grosimea Profil
1.1 mm !!!

SET (ZINCAT / VOPSIT)

în câmp electrostatic
și tratat la 200° C



LAMELA

Grosimea 0.8 mm !!!

Gard vopsit mai mare de 2500 mm
+20% la prețul calculat

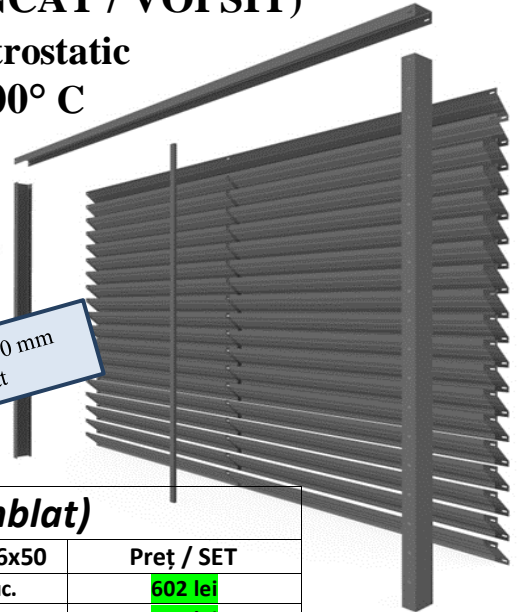

Conținutul SETului Gard Jaluze (dezasamblat)

Denumire GARD	RAL / STOC	Lamele	Cadru GJ	Nituri	Diblu 6x50	Preț / SET
GJ 1530x2000/80	8017M / 7016M	19 buc.	h – 1530 / 1 set.	100 buc.	6 buc.	602 lei
GJ 1930x2000/80	8017M / 7016M	24 buc.	h – 1930 / 1 set.	125 buc.	8 buc.	754 lei
Gard Jaluze Nestandard (dezasamblat)						Preț m2
Gard NESTANDARD				Nituri incluse (RAL standard)		230 lei/m2

Cadru Gard Jaluze 1530 x 2000/80
108 – 00 lei / set

Lamela SJ 110 x 1986
26 lei / buc.

Cadru Gard Jaluze 1930 x 2000/80
130 – 00 lei / set



Culori RAL Standard p/ u Gard Jaluze

RAL : 8017M/T – 7016M/T – 6005M/T – 3005M/T – 7012M/T – 7030M/T – 9003M/T

Maro

Gri-Negru

Verde

Vișiniu

Gri

Gri-Bej

Alb

La RAL Nestandard se adaugă +20% la prețul calculat inițial !!!!!

Gard vopsit mai mare de 2500 mm
+20% la prețul calculat



Gard Nestandard (dezasamblat) La Comandă !!!

- Gard Jaluze PAS / 100 – 210-00 lei / m2
- Gard Jaluze PAS / 120 – 190-00 lei / m2

Diferența între lungimi din 3 în 3 mm



Lungimea Maximă posibilă 4000 mm !!!!



Porți Jaluze /ZnT/ (Zincare Termică !!!)



Poartă /ZnT/GJ 1850x3400/80 **Standard!!!**
4180-00 lei/buc.

Portiță cu
 Yală
 Mecanică
 Inclusă!!!



Portiță /ZnT/GJ 1850x900/80
Standard!!!
1850-00 lei/buc.

Stâlpi p/u Porți Batante

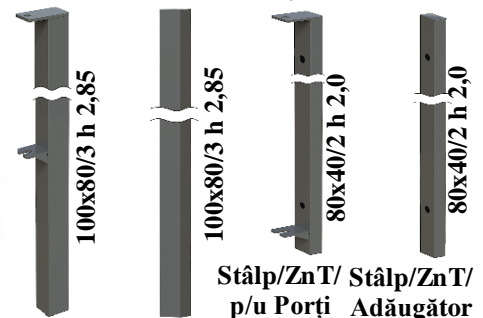

Stâlp/ZnT/ Stâlp/ZnT/
 p/u Porți Adăugător
485 lei/buc. **425 lei/buc.**
 Stâlp/ZnT/ Stâlp/ZnT/
 p/u Porți Adăugător
305 lei/buc. **245 lei/buc.**

Yală Electromecanică
 CISA



795 lei/set

Yală Mecanică



315 lei/set

Stâlpi p/u Porți
 Glisante / Autoportante

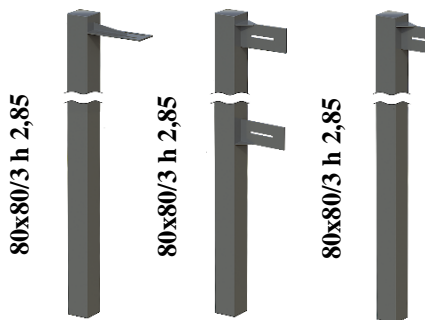

Stâlp/ZnT/
 Support **475 lei/buc.**
 Stâlp/ZnT/
 STOP Autop **475 lei/buc.**
 Stâlp/ZnT/
 STOP Glis **475 lei/buc.**



Poartă Glisantă /ZnT/GJ 1870x4000/80 **Standard!!!**
5800-00 lei/buc.

Poartă Autoportantă /ZnT/GJ

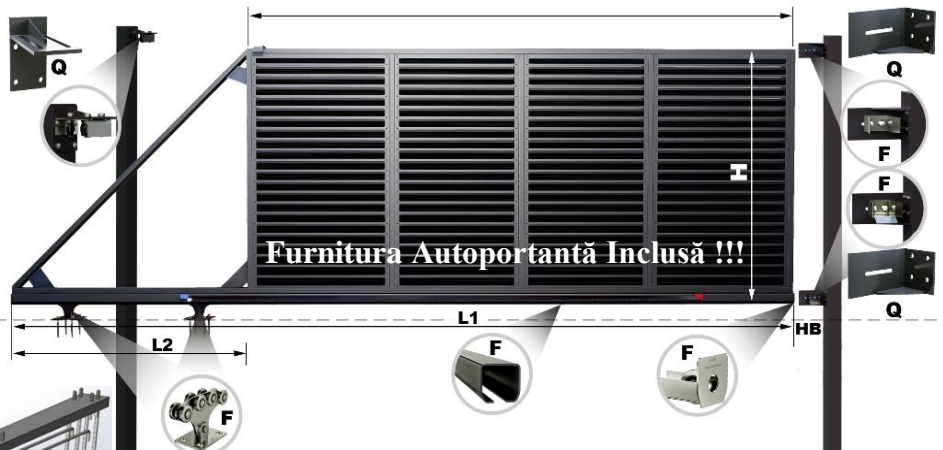

Ancor p/u Furnitură

- 700 lei** (1,5m-2,0m)/ZnT-1260 lei
- 900 lei** (2,1m-2,5m)/ZnT-1610 lei
- 1050 lei** (2,6m-3,2m)/ZnT-1930 lei



Furnitura
 Autoportantă
400kg - 475 lei/set
800kg - 820 lei/set
 Șina
 Autoportantă
400kg - 460 lei/set
800kg - 950 lei/set

Cadru
 SUPORT
 p/u
 Furnitură
ZnT - 50 lei/buc



Cadru
 STOP
 p/u
 Furnitură
ZnT - 50 lei/buc

Porți Jaluze preț / m2 !!!

Porți cu portiță inclusă + 15%

Gard Jaluze	Poartă Batantă Jaluze		Portiță Jaluze (fara yală)	Poartă Glisantă	Poartă Autoportantă
	BA/ZnT	BS/ZnT	BA/ZnT	furnitura inclusă	Furnitura inclusă/800kg
Pas/80	730	Poarta mai mare de 4 m	1020	850	1300
Pas/100	720		1010	840	1290
Pas/120	710		1000	830	1280



Gard GP-O/80 zincat (dezasamblat)

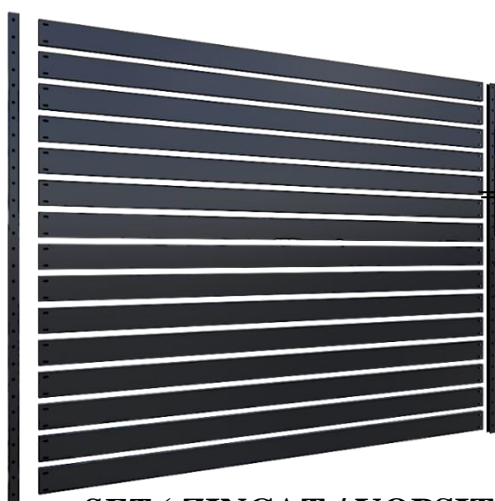

P= Distanța (mm) dintre
Lamele GP-O/80

Gard vopsit mai mare de 2500mm
+20% la prețul calculat

SET (ZINCAT / VOPSIT)
în câmp electrostatic
și tratat la 200° C

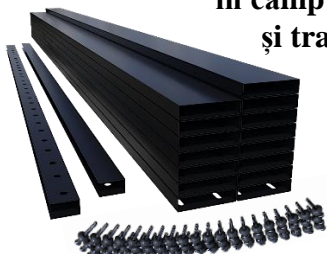

Lamela GP-O/80

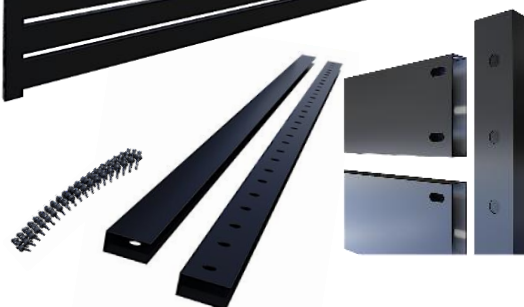

CADRU Gard GP-O/80

Conținutul SETului Gard GP-O/80 (dezasamblat)

Denumire GARD	RAL / STOC	Lamele GP-O/80	Cadru GP-O/80	Nituri	Preț / SET Standard
GP-O/80 - 1480x2000/P20	8017M / 7016M	15 buc.	h – 1480 / 1 set.	70 buc.	830lei
GP-O/80 - 1880x2000/P20	8017M / 7016M	19 buc.	h – 1880 / 1 set.	80 buc.	1050 lei

Gard GP-O/80 Nestandard (dezasamblat)

Gard NESTANDARD	Nituri Incluse (RAL standard)		Preț m2 lungimea 2000mm	Preț m2 lungime diferita de 2000mm
			P=0	340 lei
		P=10	310 lei	<i>360 lei</i>
		P=20	280 lei	<i>320 lei</i>
		P=30	270 lei	<i>310 lei</i>
		P=40	260 lei	<i>300 lei</i>

Gard nestandard Nituri incluse (RAL standard) cu Lungimea si Înălțimea **DIFERITA !!!**



Profil 37x22x37 – 28 lei/m.l.

CADRU GP-O/80

GP-O/80 - 1480x2000/P20 – 80 lei./set
 GP-O/80 - 1880x2000/P20 – 100 lei./set



Lamela GP-O/80 (L 1986) RAL
– 50 lei./buc.(25 lei/m.l.)





Porți GP-O/80 /ZnT/ (Zincare Termică !!!)

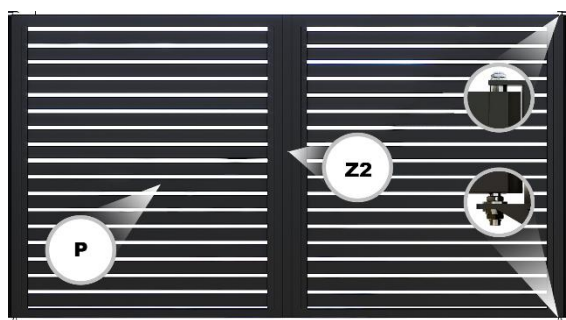

Poartă /ZnT/GP-O/80
 1850x3400/20- 4600 lei



Portiță /ZnT/ GP-O/80
 1850x900/20- 2080 lei

Stâlpi p/u Porți Batante

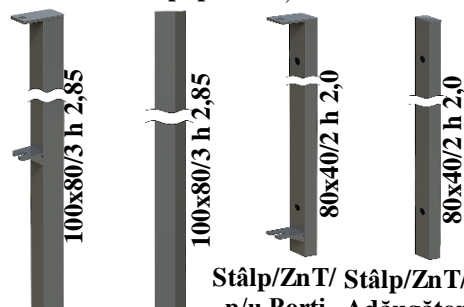

Stâlp/ZnT/ p/u Porți 485 lei/buc.
Stâlp/ZnT/ Adăugător 425 lei/buc.
Stâlp/ZnT/ p/u Porți 305 lei/buc.
Stâlp/ZnT/ Adăugător 245 lei/buc.

Yală Electromecanică CISA



795 lei/set

Yala Mecanică



315 lei/set

Stâlpi p/u Porți Glisante / Autoportante

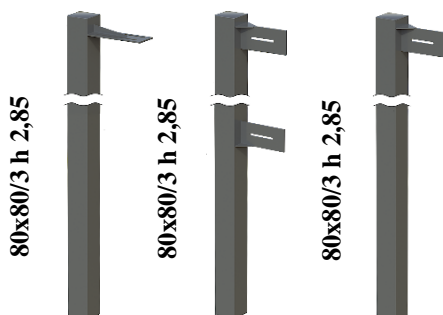

Stâlp/ZnT/ Support 475 lei/buc.
Stâlp/ZnT/ STOP Autop. 475 lei/buc.
Stâlp/ZnT/ STOP Glis 475 lei/buc.

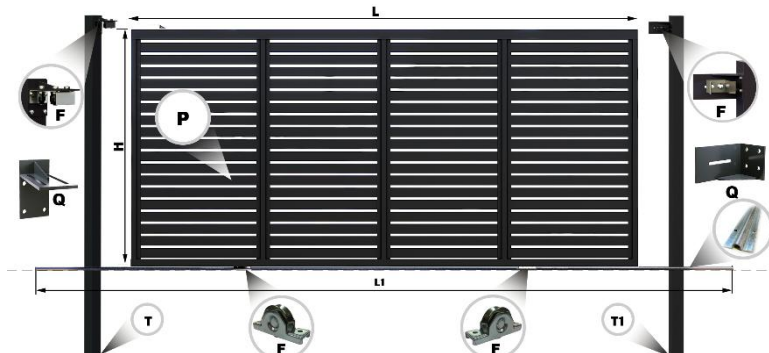

Poartă Glisantă /ZnT/ GP-O/80
 1870x4000/20- 6250 lei

Poarta Autoportantă /ZnT/ GP-O/80

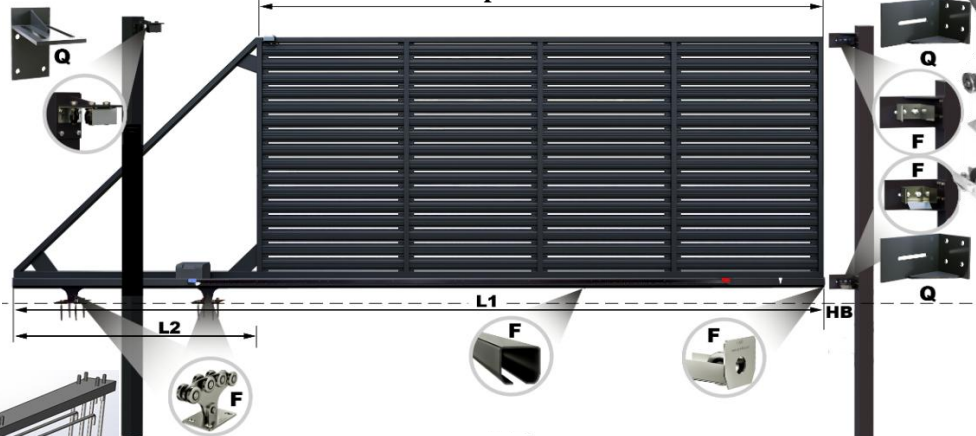

Furnitură Autoportantă
 400kg - 475 lei/set
 800kg - 820 lei/set

Sină Autoportantă
 400kg - 460 lei/set
 800kg - 950 lei/set

Cadru SUPORT p/u Furnitură ZnT - 50 lei/buc

Cadru STOP p/u Furnitură ZnT - 50 lei/buc

Ancor p/u Furnitură

700 lei (1,5m-2,0m)/ZnT-1260 lei
 900 lei (2,1m-2,5m)/ZnT-1610 lei
 1050 lei (2,6m-3,2m)/ZnT-1930 lei

Porți GP-O/80 - pret / m2 !!!

Porți cu portița inclusă + 15%

Gard GP-O/80	Poartă Batantă GP-O/80 (preț lei/m2)		Portiță GP-O/80 (Fără Yală) (preț lei/m2)	Poartă Glisantă / Autoportantă GP-O/80 (preț lei/m2)	
	BA /ZnT	BA-XL /ZnT	BA /ZnT	Glisantă (furnitura inclusă) ZnT	Autoportantă / 800kg (furnitura inclusă) ZnT
GP-O/80 P=0	930	Poarta mai mare de 4m	1290	1020	1555
GP-O/80 P=10	850		1175	970	1480
GP-O/80 P=20	830		1150	940	1450
GP-O/80 P=30	810		1115	915	1425
GP-O/80 P=40	790		1095	905	1410



Gard XL-O ZINCAT (dezasamblat)

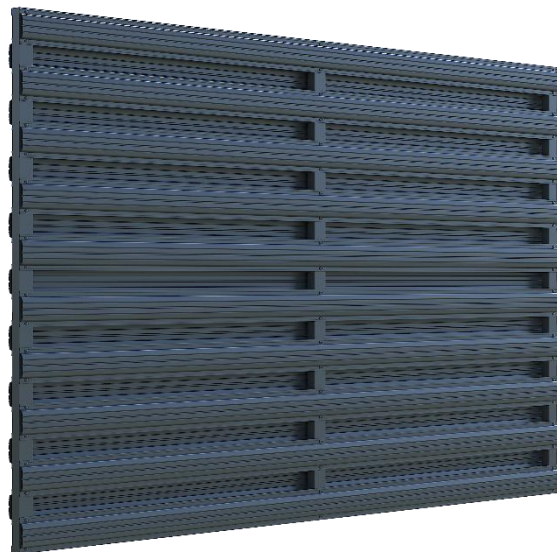
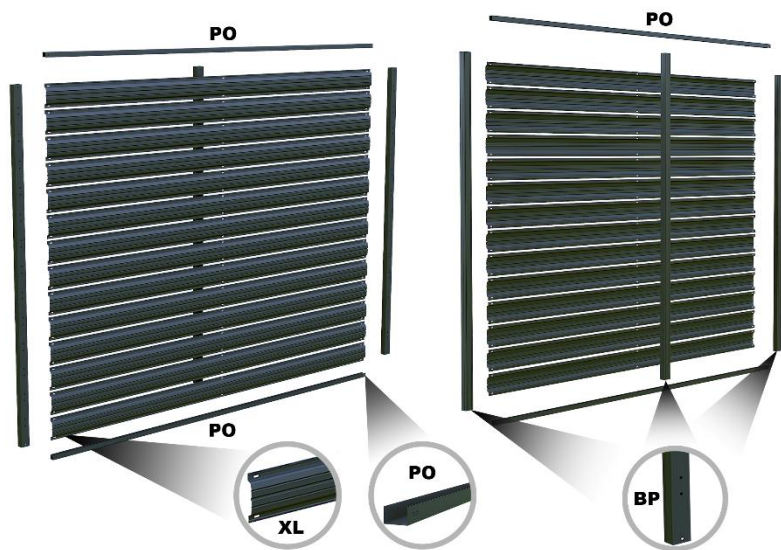

Gard vopsit mai mare de 2500 mm
+20% la pretul calculat

SET (ZINCAT / VOPSIT)
în câmp electrostatic
și tratat la 200° C

Șipcă XL-O
Grosimea Șipcii – 0.65 mm !!!

CADRU Gard XL-O

Profil U zinc /XL-O – 11 lei/m.l.

Cornier/XL-O RAL– 9 lei/m.l.

Șipcă XL-O 100x1993 – 20 lei

Bara Zn 40x27 perforata – 15 lei/m.l
cu dibluri și nituri incluse

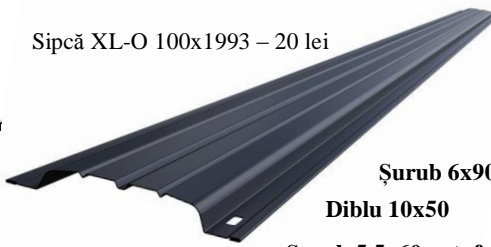

Șurub 6x90

Diblu 10x50

Șurub 5.5x60 autoforant

Compoziția SETului Gard XL-O (dezasamblat)

GARD Standard !!! XL-O	RAL / STOC	Șipcă XL- O/zinc/Perforat	Cadru XL-O	Nituri	Diblu + șurub 8x40 + 5x80	Șurub 5,5x60 autoforant	Preț / SET
XL-O 1500x2000/23 dublu	8017M / 7016M	17 buc. (75mm)	h-1500 / 1 set	110 buc.	6 set-uri	6 buc.	445 lei
XL-O 1800x2000/23 dublu	8017M / 7016M	21 buc. (70mm)	h-1800 / 1 set	135 buc.	8 set-uri	8 buc.	540 lei
XL-O 1500x2000/18	8017M / 7016M	14 buc. (8mm)	h-1500 / 1 set	90 buc.	6 set-uri	6 buc.	385 lei
XL-O 1800x2000/18	8017M / 7016M	16 buc. (13mm)	h-1800 / 1 set	105 buc.	8 set-uri	8 buc.	440 lei

Gard XL-O La Comandă !!!	Dezasamblat preț / M2	Compoziția Gardului Dezasamblat - XL-O /zinc/Perforat - Bară perforată 40x27 RAL - Profil U/XL-O - Cornier - Nituri RAL standard Adaugă elementele de fixare (șurub, diblu, fixator)
	L - nestandard	
XL-O / 23 Dublu (55-75mm)	160	
XL-O / 11 (55-75mm)	100	
XL-O / 14 (30-55mm)	110	
XL-O / 16 (15-30mm)	120	
XL-O / 18 (7-15mm)	130	

CADRU Gard XL-O

XL-O 1500x2000/23 dublu – 105 lei./set
XL-O 1800x2000/23 dublu – 120 lei./set
XL-O 1500x2000/18 – 105 lei./set
XL-O 1800x2000/18 – 120 lei./set

Diferența între lungimi din 3 în 3mm



Porți XL-O /ZnT/ (Zincare Termică !!!)

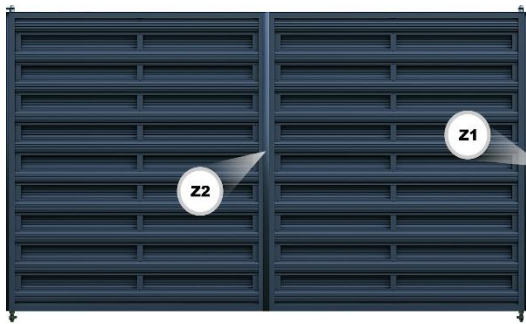

Poartă /ZnT/XL-O/zinc/BA
 1850x3400/23 – 3750 lei
 1850x3400/18 – 3650 lei

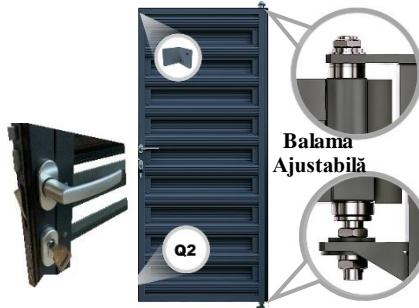

Portiță /ZnT/ XL-O/BA
 1850x900/23 – 1700 lei
 1850x900/18 – 1650 lei

Stâlpi p/u Porți Batante

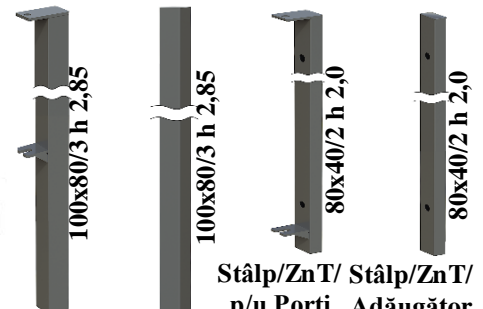

Stâlp/ZnT/ p/u Porți 485 lei/buc.
Stâlp/ZnT/ Adăugător 425 lei/buc.
Stâlp/ZnT/ p/u Porți 305 lei/buc.
Adăugător 245 lei/buc.

Yala Electromecanică CISA



795 lei/set

Yala mecanica



315 lei/set

Stâlpi p/u Porți Glisante / Autoportante

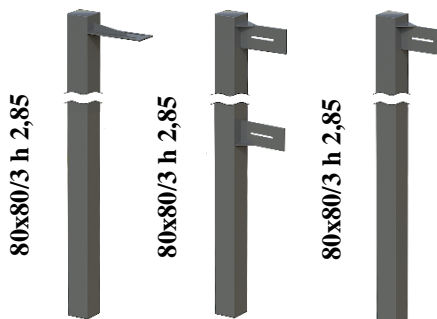

Stâlp/ZnT/ Support 475 lei/buc.
Stâlp/ZnT/ STOP Culis 475 lei/buc.
Stâlp/ZnT/ STOP Glis 475 lei/buc.



Poartă Glisantă /ZnT/ XL-O/zinc

1870x4000/23 – 5400 lei
 1870x4000/18 – 5300 lei

Poartă Autoportantă /ZnT/ XL-O/zinc

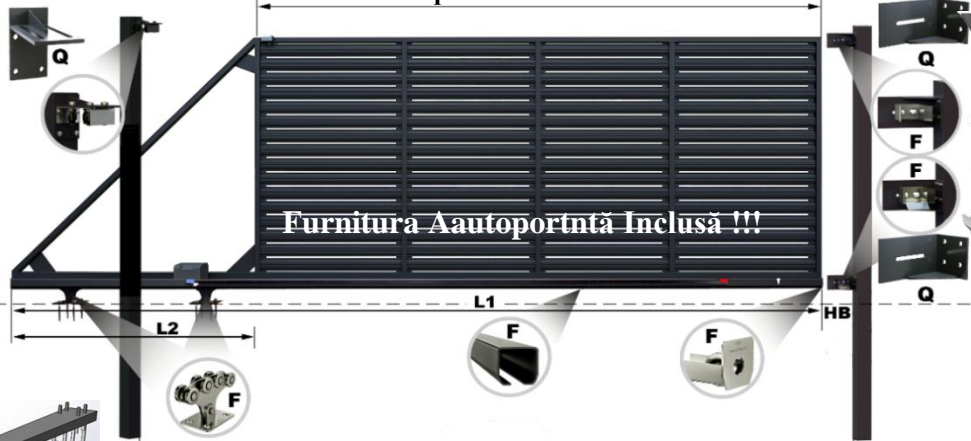

Furnitură Autoportantă

400kg – 475 lei/set
 800kg – 820 lei/set

Șină Autoportantă

400kg – 460 lei/set
 800kg – 950 lei/set

Cadru SUPORT p/u Furnitură ZnT - 50 lei/buc

Cadru STOP p/u Furnitură ZnT - 50 lei/buc

Ancor p/u Furnitură

700 lei (1,5m-2,0m)/ZnT-1260 lei
 900 lei (2,1m-2,5m)/ZnT-1610 lei
 1050 lei (2,6m-3,2m)/ZnT-1930 lei

Porți XL-O/zinc - preț / m2 !!!

Porți cu portița inclusă + 15%

Gard XL-O	Poartă Batantă XL-O (preț lei/m2)		Portiță XL-O (Fără Yală) (preț lei/m2)	Poarta Glisantă /Autoportantă XL-O (preț lei/m2)	
	BA /ZnT	BA-XL /ZnT	BA /ZnT	Glisantă (furnitura inclusă) ZnT	Autoportantă (furnitura inclusă / 800kg) ZnT
XL-O / 23 Dublu	650	Poarta mai mare de 4m	920	800	1200
XL-O / 11 (70mm)	610		850	750	1150
XL-O / 14 (40mm)	620		860	760	1160
XL-O / 16 (20mm)	630		880	770	1170
XL-O / 18 (10mm)	640		890	780	1180



Gard Șipcă ZINCAT (0.63 mm) VOPSIT *dezasamblat*

XL/18

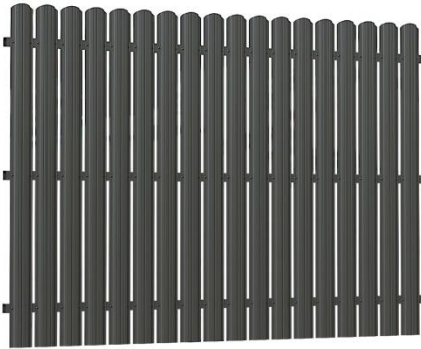

H-mm	L-mm	Panou XL-18 (8mm)
600	2000	145 lei
1500	2000	305 lei
1800	2000	360 lei
LA COMANDĂ!		120 lei/m ²

XL/23(dublu)

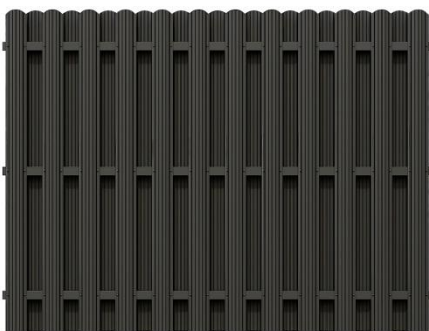

H-mm	L-mm	Panou XL-23 (dublu)
600	2000	170 lei
1500	2000	370 lei
1800	2000	440 lei
LA COMANDĂ!		140 lei/m ²

Fixaj pentru gard șipcă

	120x40x20	160x40/120x40	80x40	40x40
RAL	6 lei	5 lei	4 lei	4 lei
RAL Antik	7 lei	6 lei	5 lei	5 lei

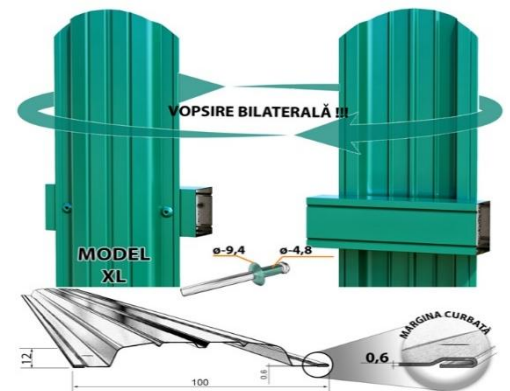

Componența set = Bară perforată (40x27) + Nituri + Șipcă

	La bucată		La metru linear	
	RAL	ANTIK	RAL	ANTIK
Șipcă XL 100x1500	13 lei	14 lei	9 lei	10 lei
Bara Zn 40x27 (L-2000)+nituri	23 lei	25 lei	12 lei	13 lei



Culorile de Vopsea Polimeră

RAL-70161

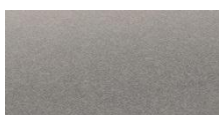

Gri-Negru
Mat Texturat

RAL-80171



Maro
Mat Texturat

RAL-801



Cupru
Antik

RAL-856

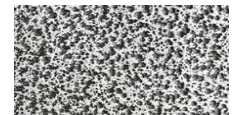

Argintiu
Antik

La RAL Nestandard se adaugă +20% la prețul calculat inițial !!!!!



Porți Șipcă Zincată XL /ZnT/ (Zincare Termică !!!)



Poartă /ZnT/BA/GS

Portiță cu
Yală Simplă
Inclusă!!!



Balama Ajustabilă

Portiță /ZnT/GS

Stâlpi p/u Porți Batante

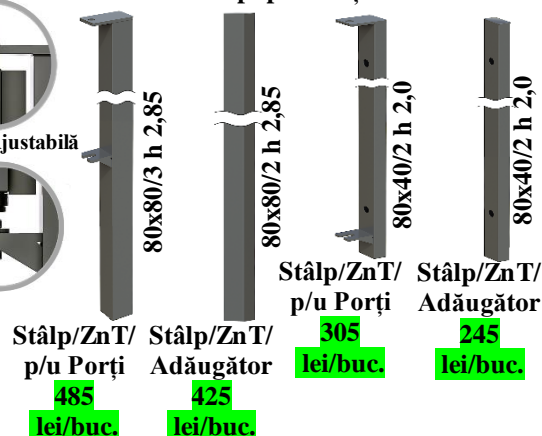

Stâlp/ZnT/
p/u Porți
485
lei/buc.

Stâlp/ZnT/
Adăugător
425
lei/buc.

Stâlp/ZnT/
p/u Porți
305
lei/buc.

Stâlp/ZnT/
Adăugător
245
lei/buc.

Yală Electromecanică
CISA



795 lei/set

Yală Mecanică



315lei/set

Stâlpi p/u Porți
Glisante / Autoportante

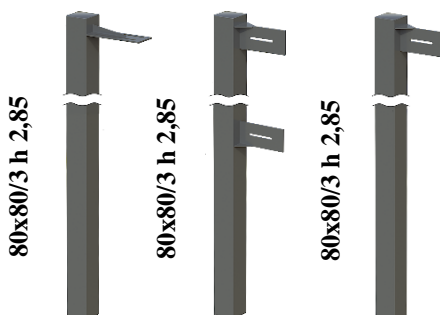

Stâlp/ZnT/
Support
475 lei/buc.

Stâlp/ZnT/
STOP Autop.
475 lei/buc.

Stâlp/ZnT/
STOP Glis
475 lei/buc.



Poartă Glisantă /ZnT/GS

Poarta Culisantă /ZnT/GS

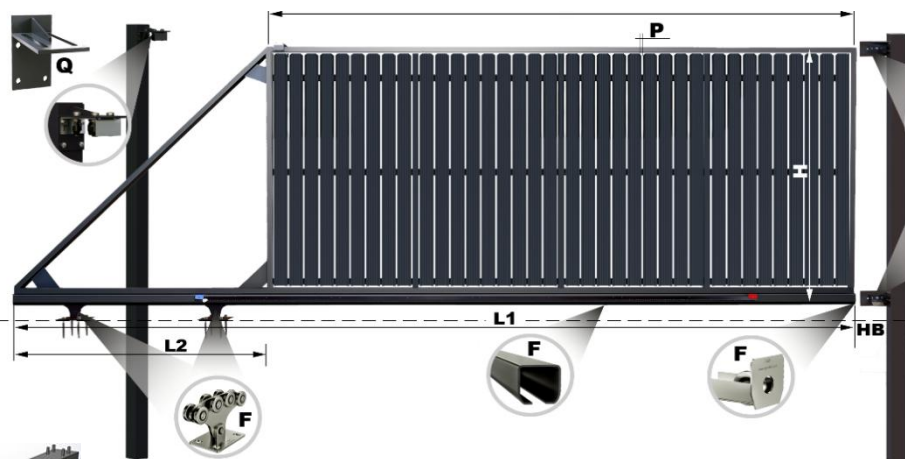

Furnitură
Aautoportantă

400kg – 475 lei/set
800kg – 820 lei/set

Șină
Aautoportantă

400kg – 460 lei/set
800kg – 950 lei/set

Cadru
SUPPORT
p/u
Furnitură
ZnT - 50 lei/buc

Cadru
STOP
p/u
Furnitură
ZnT - 50 lei/buc

Ancor p/u Furnitură

800 lei (1,5m-2,0m)/ZnT-1260 lei
900 lei (2,1m-2,5m)/ZnT-1610 lei
1050 lei (2,6m-3,2m)/ZnT-1930 lei

Porți Șipcă – preț/m2!!!

Porți cu portiță inclusă + 15%

Gard Șipcă	Poartă Batantă Șipcă (preț lei/m2)		Portiță Șipcă (Fără Yală) (preț lei/m2)	Poarta Glisantă / Aautoportantă Șipca (preț lei/m2)	
	BA /ZnT	BA-XL /ZnT	BA /ZnT	Glisantă (furnitura inclusă) ZnT	Autoportantă (furnitura inclusă/800kg) ZnT
XL-18	500	Poarta mai mare de 4 m	800	720	1140
XL-23	515		815	730	1170



Gard GP/80x20 /ZnT/(Zincare Termică !!!)

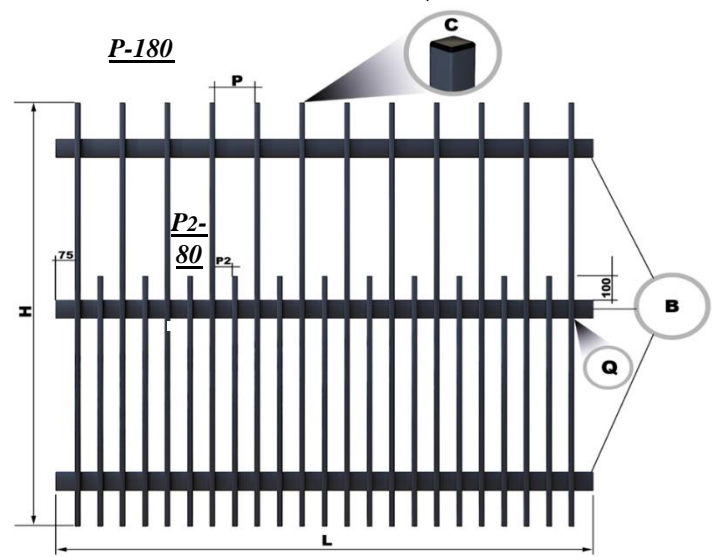
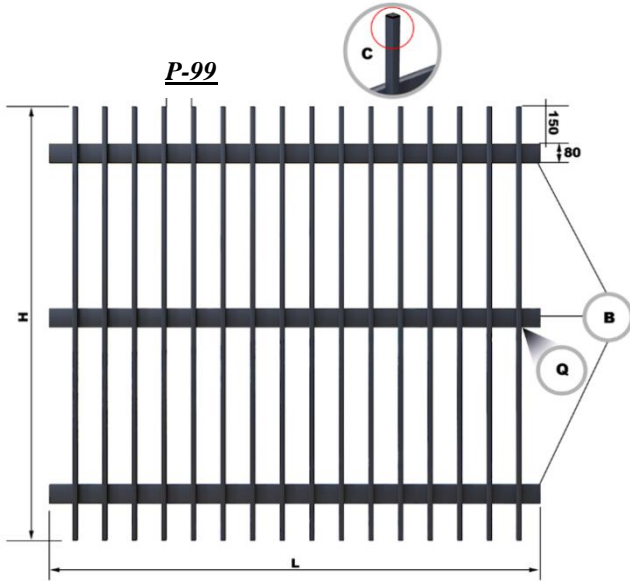

Denumire GP / 80x20	B (buc)	P = 99mm				P = 180mm / P2 = 80mm				P = 60mm			
		Pret ZnT standart	Pret Zn T nestand.	Pret Zn T/ vopsit standart	Pret Zn T/ vopsit nestand.	Pret ZnT standart	Pret Zn T nestand	Pret Zn T/ vopsit standart	Pret ZnT/ vopsit nestand	Pret ZnT standart	Pret Zn T nestand	Pret Zn T/ vopsit standart	Pret Zn T/ vopsit nestand
800x2000	2	525		595		-----		-----		675		770	
1000x2000	2	575		655		-----		-----		760		865	
1200x2000	2 / 3	645	+20%	730	+20%	850	+20%	965	+20%	860	+20%	985	+20%
1500x2000	2 / 3	710		810		915		1040		975		1120	
2000x2000	3	980		1115		1060		1205		1335		1530	

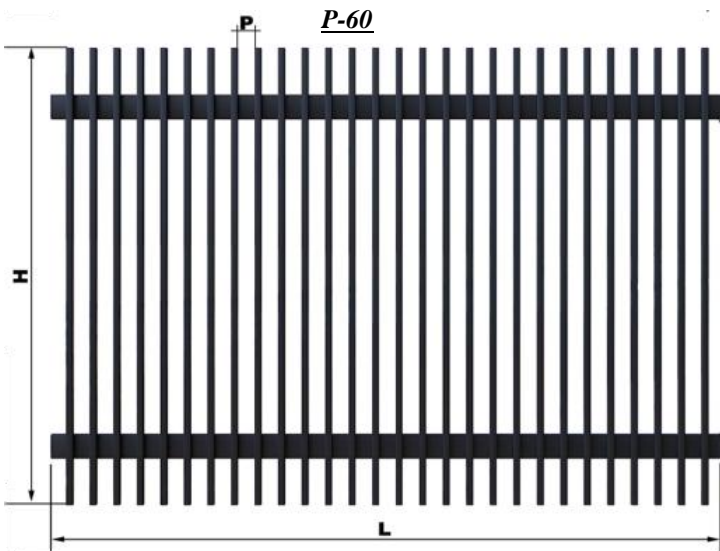

Gard vopsit mai mare de 2500 mm +20% la pretul calculat





Porți GP/80x20 /ZnT/ (Zincare Termică !!!)



Poartă /ZnT/ GP/80x20



Portiță /ZnT/ GP/80x20

Stâlpi pentru Porți Batante

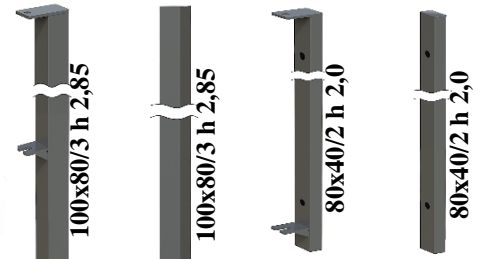

Stâlp/ZnT/ p/u Porți Adăugător **485 lei/buc.**
 Stâlp/ZnT/ p/u Porți Adăugător **425 lei/buc.**
 Stâlp/ZnT/ p/u Porți **305 lei/buc.**
 Stâlp/ZnT/ Adăugător **245 lei/buc.**

Yală Electromecanic CISA



795 lei/set

Yală Mecanică



315 lei/set

Stâlpi pentru Porți Glisante / Autoportante

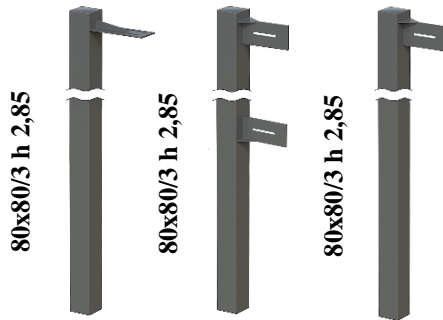

Stâlp/ZnT/ Support **475 lei/buc.**
 Stâlp/ZnT/ STOP Aautop. **475 lei/buc.**
 Stâlp/ZnT/ STOP Glis **475 lei/buc.**

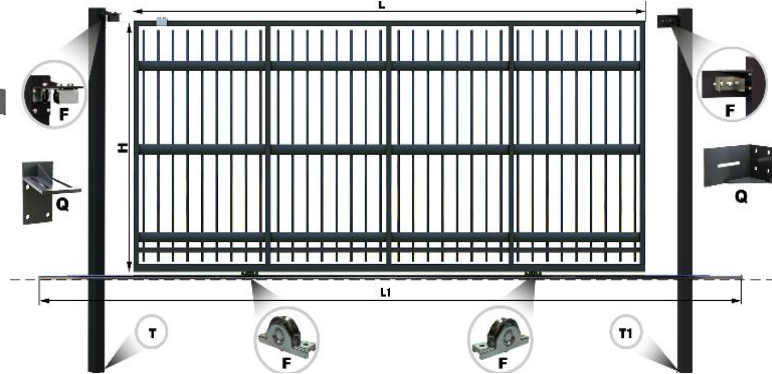

Poartă Glisantă /ZnT/ GP/80x20

Poartă Autoportantă /ZnT/ GP

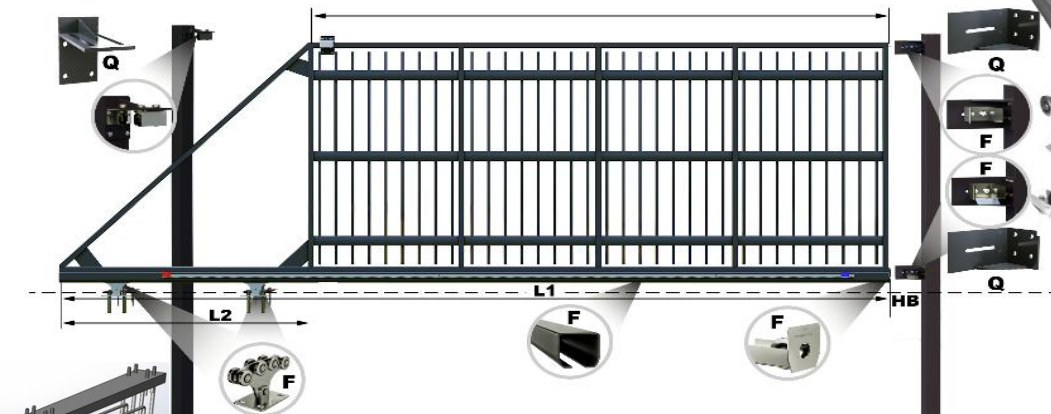

Ancor p/u Furnitură

700 lei (1,5m-2,0m)/ZnT-1260 lei
900 lei (2,1m-2,5m)/ZnT-1610 lei
1050 lei (2,6m-3,2m)/ZnT-1930 lei

Porti GP/80x20 - preț / m2 !!!

Porti cu portița inclusă + 15%

Furnitură Autoportantă

400kg - 475 lei/set
800kg - 820 lei/set

Șină Autoportantă

400kg - 460 lei/set
800kg - 950 lei/set

Cadru SUPORT p/u Furnitură **ZnT - 50 lei/buc**

Cadru STOP p/u Furnitură **ZnT - 50 lei/buc**

Gard GP/80x20	Poartă Batantă GP/80x20 (preț lei/m2)			Portiță GP/80x20 (Fără Yală) (preț lei/m2)		Poarta Glisantă / Autoportantă GP/80x20 (preț lei/m2)			
	BA /ZnT	BA/ZnT /Vopsită	BA-XL /ZnT	BA /ZnT	BA/ZnT /Vopsită	Glisantă (furnitura inclusă)		Autoportantă / 800kg	
						ZnT	ZnT/Vopsită	ZnT	ZnT/Vopsită
P = 99mm	635	740	Poarta mai mare de 4 m	1225	1330	810	950	1230	1240
P = 180mm / P2 = 80mm	665	780		1285	1400	850	990	1295	1300
P = 60mm	695	810		1345	1460	850	1040	1355	1360



Porți din Panou Bordurat/ZnT/ (Zincare Termică !!!)

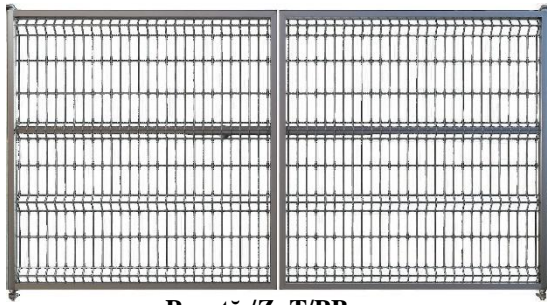

Poartă /ZnT/PB



Portiță /ZnT/PB

Stâlpi p/u Porți Batante

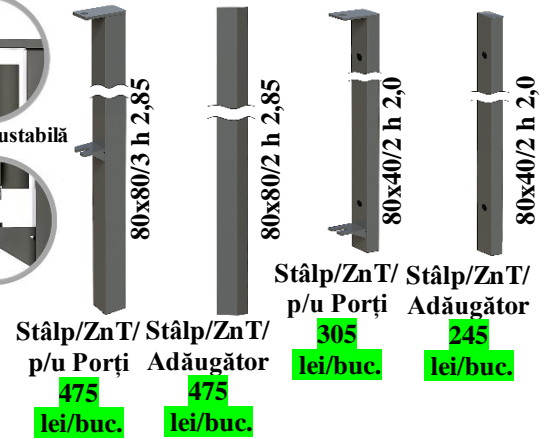

Yală Electromecanică CISA



795 lei/set

Yală Mecanică



315 lei/set

Stâlpi p/u Porți Glisante / Autoportante

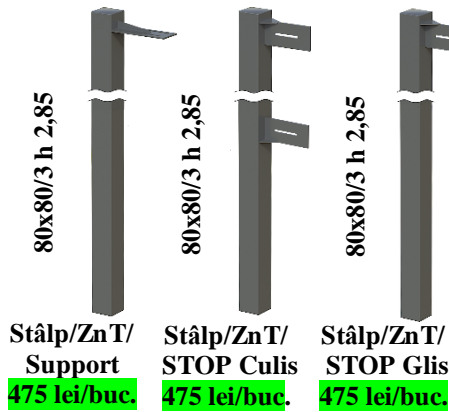

Poartă Autoportantă /ZnT/PB

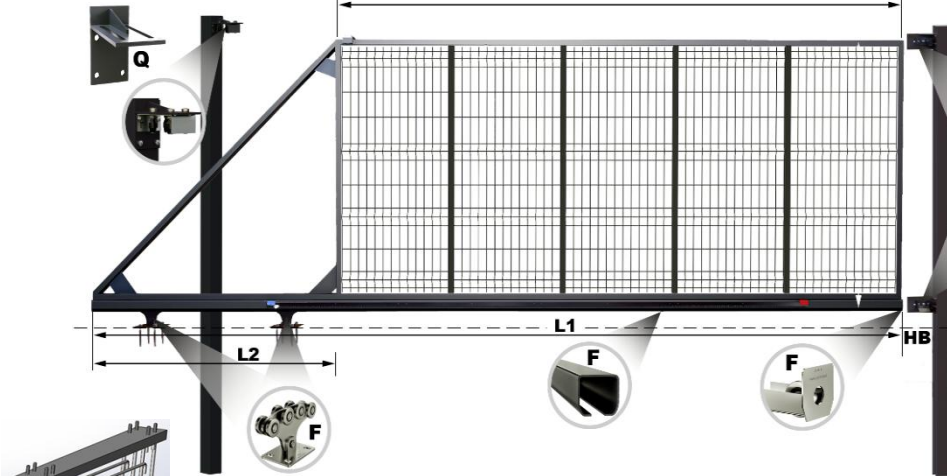

Ancor p/u Furnitură

700 lei (1,5m-2,0m)/ZnT-1260 lei
 900 lei (2,1m-2,5m)/ZnT-1610 lei
 1050 lei (2,6m-3,2m)/ZnT-1930 lei

Porți din Panou Bordurat preț / m2 !!!

Porți cu portiță inclusă + 15%

Panou Bordurat	Poartă Batantă PB (preț lei/m2)			Portiță PB (Fără Yală) (preț lei/m2)		Poartă Glisantă / Autoportantă PB (preț lei/m2)			
	BA Vopsit/ZnT	BA /ZnT	BA-XL /ZnT	BA Vopsit/ZnT	BA /ZnT	Glisantă (furnitura inclusă)		Autoportantă (furnitura inclusă / 800kg)	
						Vopsit/ZnT	ZnT	Vopsit/ZnT	ZnT
d-4,2	585	475	Poarta mai mare de 4 m	1120	975	725	630	1290	1030



Stâlpi metalici

- zincăți termic
- acoperiți cu vopsea polimer
- dop plastic inclus

	40x40/2	50x50/2	60x60/2
h	ZnT/Vopsit	ZnT/Vopsit	ZnT/Vopsit
1.0	70	86	103
1.2	82	101	121
1.4	97	119	143
1.5	100	124	149
1.8	124	153	183
2.0	131	162	194
2.2	160	197	236
2.4	167	206	247
2.6	175	216	259
2.8	182	225	270
3.0	190	234	281

	60x60/3	60x60/4	80x80/2	80x80/3	80x80/4
h	ZnT/Vopsit	ZnT/Vopsit	ZnT/Vopsit	ZnT/Vopsit	ZnT/Vopsit
1.0	134	164	117	150	187
1.2	158	195	138	177	221
1.4	187	232	162	209	263
1.5	195	241	169	218	273
1.8	241	299	208	269	339
2.0	255	317	221	286	360
2.2	312	389	267	347	439
2.4	327	407	280	364	461
2.6	342	426	293	381	482
2.8	357	444	306	399	503
3.0	371	463	319	416	525

	100x100/3	100x100/4	100x100/5	60x30/2	60x30/3
h	ZnT/Vopsit	ZnT/Vopsit	ZnT/Vopsit	ZnT/Vopsit	ZnT/Vopsit
1.0	190	224	264	94	118
1.2	225	265	313	107	136
1.4	266	315	372	124	158
1.5	277	327	387	128	164
1.8	341	405	481	153	199
2.0	363	431	511	162	210
2.2	441	525	624	192	253
2.4	463	551	654	201	264
2.6	484	576	685	209	275
2.8	505	602	715	218	287
3.0	527	628	746	227	298

	60x40/2	60x40/3	80x20/2	80x40/2	80x40/3
h	ZnT/Vopsit	ZnT/Vopsit	ZnT/Vopsit	ZnT/Vopsit	ZnT/Vopsit
1.0	100	125	104	130	146
1.2	115	145	119	149	170
1.4	132	168	137	173	199
1.5	137	175	142	178	206
1.8	165	212	171	215	251
2.0	174	225	180	227	266
2.2	207	270	215	274	320
2.4	217	282	224	285	335
2.6	226	295	234	296	350
2.8	235	307	243	308	365
3.0	245	320	253	319	380

	80x60/2	100x80/3	120x120/3	120x120/4	140x140/4
h	ZnT/Vopsit	ZnT/Vopsit	ZnT/Vopsit	ZnT/Vopsit	ZnT/Vopsit
1.0	123	160	218	269	314
1.2	143	188	257	318	371
1.4	166	220	303	377	440
1.5	172	229	315	393	457
1.8	208	281	389	485	565
2.0	221	299	413	516	601
2.2	262	358	500	628	731
2.4	275	376	525	659	767
2.6	288	395	550	689	802
2.8	301	413	574	720	837
3.0	314	432	599	751	872



Sisteme automate de deschidere p/u Porți Batante



Mastiff 300 (Bi-Folding) (Wi-Fi)	<ul style="list-style-type: none"> - Motor 2 buc. - Kit Wi-Fi -1buc, - element foto 2 buc. - telecomanda 2 buc. - Semnal 1 buc. 	1950
Mastiff 400 (Wi-Fi)		2150
Mastiff 400L (Wi-Fi)		2400

Sisteme automate de deschidere p/u Porți Autoportante / Glisante



Miller Technics MT-1000	<ul style="list-style-type: none"> - motor 1buc. - element foto 2 buc. - telecomanda 2 buc. 	1850
--------------------------------	--	-------------

Cremalieră zin.

55.0 lei/buc (1 m)



Telecomandă

60.0 lei/buc



Semnal

100.0 lei/buc



Furnitura p/u Porți Autoportante

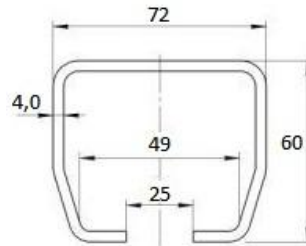

400kg

935-00 lei/set

(furnitura - 475 lei / Balka - 460 lei)

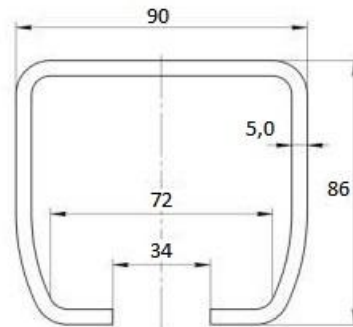

800 kg

1770-00 lei/set

(furnitura - 820 lei / Balka - 950 lei)

